



# **IBDoc<sup>®</sup> Calprotectin Kit**

## **Instructions for Use Patients and Lay Users**

invalid

LF-IBDOC8

8 tests

Version 6.0: 08-04-2024

# TABLE OF CONTENTS

TABLE OF CONTENTS	2
INTENDED USE	2
PRINCIPLE OF THE ASSAY	3
MATERIALS AND ACCESSORIES	4
IMPORTANT INFORMATION	5
COMPONENTS OF THE IBDoc® TEST KIT	6
STEP 1: INSTALLATION OF THE APP AND LOGIN	8
STEP 2: PREPARATIONS FOR THE TEST PROCEDURE	9
STEP 3: STOOL COLLECTION	10
STEP 4: STOOL EXTRACTION	11
STEP 5: LOADING THE TEST CASSETTE	12
STEP 6: READING THE TEST CASSETTE	13
STEP 7: ADDING NOTES AND SAVING TEST RESULT	14
QUALITY CONTROL FEATURES	15
CRITICAL STEPS IN THE TEST PROCEDURE	15
NOTES	16
INFORMATION	17
LIMITATIONS AND CONTRAINDICATIONS	18
RESULT INTERPRETATION	19
SUMMARY OF CLINICAL LITERATURE	20
PERFORMANCE CHARACTERISTICS	22
BIBLIOGRAPHY	31

## INTENDED USE

### INTENDED USE

BÜHLMANN IBDoc® is an *in vitro* diagnostic immunoassay for the quantitative determination of fecal calprotectin in human stool. The results of the assay are analyzed by a downloadable smartphone application. IBDoc® is intended as an aid to the assessment of inflammation of the intestinal mucosa for inflammatory bowel disease (e.g. Crohn's Disease and ulcerative colitis) monitoring. IBDoc® is an assay developed for self-testing / home use by trained patients ages 12 and above that are under the care of a healthcare practitioner. The test may also be used in a near-patient or laboratory setting.

Disclaimer: The screenshots in this instruction for use are based on the iOS version of the IBDoc® app. The Android version might differ in layout but not in functionality.

## PRINCIPLE OF THE ASSAY

IBDoc® is a home test to measure calprotectin in stool samples for patients ages 12 and above. Calprotectin is a protein released by neutrophilic immune cells, which are a hallmark of acute inflammation. Determination of fecal calprotectin levels helps to detect gastrointestinal (GI) inflammation and monitor inflammatory bowel disease (IBD). Low levels of calprotectin are an indication to your healthcare practitioner that you are in a state of IBD disease remission. Your treatment can be continued without any additional endoscopic, radiologic or other investigations. High calprotectin levels can act as a red flag signal for a possible GI tract inflammation. This will prompt further clinical and laboratory evaluation by your healthcare practitioner.

To determine calprotectin levels you will use the CALEX® Valve extraction device to collect a precise amount of stool sample. Inside the CALEX® Valve, calprotectin present in the stool sample is transferred to the extraction solution. The extract is then applied to the test cassette. Calprotectin in the sample is bound by anti-calprotectin antibodies linked to red gold particles. The red calprotectin-antibody-gold particles flow with the extract through the test cassette, are caught on and color the Test Line. Antibody-gold particles, not bound to calprotectin will color the Control Line. The Test and Control Lines are measured by a smartphone application (IBDoc® app.). The result is calculated by IBDoc® app. and sent to a secure server for the healthcare practitioner to review. The test has a measuring range of 30-1000 µg calprotectin / g stool and a linear range up to 850 µg/g.

invalid

## MATERIALS AND ACCESSORIES PROVIDED IN ONE *IBDoc*<sup>®</sup> TEST SET (B-IBDOC):

Before running the test, please ensure that all components are in the set.

Quantity	Kit Components
1	CALEX <sup>®</sup> Valve Device filled with extraction solution (5 mL)
1	Test Cassette
2	Stool Collection Papers
1	Quick Guide

**THE *IBDoc*<sup>®</sup> TEST KIT MUST BE STORED IN THE REFRIGERATOR (2–8 °C).**

## MATERIALS AND ACCESSORIES REQUIRED, BUT NOT PROVIDED WITH THE TEST KIT:

- iOS or Android smartphone validated by BÜHLMANN for the use with *IBDoc*<sup>®</sup>.
- You can find a complete list of validated smartphones on [www.ibdoc.net](http://www.ibdoc.net).
- An internet connection on your smartphone (see also important information).
- The smartphone application „*IBDoc*<sup>®</sup>“: Available from the Apple App Store or Google Play Store.
- Examination gloves, if necessary available from your doctor.

# IMPORTANT INFORMATION

- **Disease management should be performed together with your healthcare practitioner (HCP). Do not adapt your treatment without consultation.**
- Contact your HCP if:
  - you feel that the IBDoc<sup>®</sup> result does not reflect your current health status.
  - the result is not displayed properly (see picture 5, page 14 and chapter result interpretation, page 19).
  - you have any questions about IBDoc<sup>®</sup>.
- Please read the instruction for use carefully before starting the test procedure. Pages 6 to 7 contain an overview of all kit components. The step by step procedure walkthrough starts on page 8.
- Make sure that you are properly trained by your HCP before performing the test.
- Take your time to perform the test at your home and make sure you are not distracted.
- Keep your smartphone away from water to avoid damage.
- Additional costs for your internet connection may arise depending on your carrier.
- You can perform the IBDoc<sup>®</sup> test under different lighting conditions, but you must prevent direct sunlight, strong sideward-light or casting a shadow onto the test cassette while reading the test cassette in test procedure - step 6.
- Your smartphone must have at least 20 % of battery charge left or connected into a power source.
- The CALEX<sup>®</sup> Valve and the test cassette must not be used after the expiry date printed on the labels. The test cassette is stable at room temperature for 4 hours after opening the pouch.
- The CALEX<sup>®</sup> Valve and the test cassette must not be reused.
- None of the components are poisonous or otherwise hazardous.
- For hygienic reasons, dispose of test components as soon as they are used and wash your hands.
- A link to set your password will be sent to your IBDoc<sup>®</sup> email (username), which you provided to your HCP. If you fail to receive this message then check your spam folder.
- If the blue protection cap (figure 3, page 6) of the CALEX<sup>®</sup> Valve seems loose or has fallen off when opening the package, place it back on the outlet.
- If either the pouch holding the test cassette is damaged or the CALEX<sup>®</sup> Valve is leaking after opening the original packaging, do not use the test kit.

## IMPORTANT ADVICE FOR CORRECT TEST HANDLING

- **Many stool samples require up to 2 hours to fully detach** from the grooves (step 4, p. 11). It may be easiest to prepare and extract your stool sample (as described in test procedure - step 3 and 4) in the morning and continue with the next steps in the evening. Do not leave the processing of the extract for more than 24 hours. In this way, the stool sample has enough time to completely detach from the grooves and you are not under any time pressure for the rest of the test procedure.
- If you have problems to collect the stool sample i.e. the stool does not stick to the grooves of the CALEX<sup>®</sup> Valve device, perform the test on another day. Use a new IBDoc<sup>®</sup> test.

## CALEX® Valve device

Figure 1:

CALEX® Valve

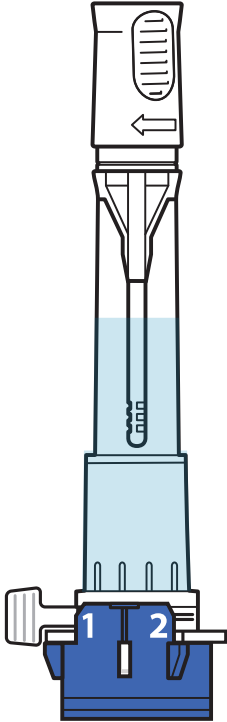

Figure 2:

Sampling pin

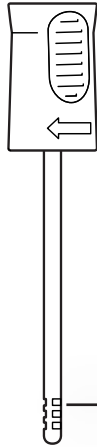

Figure 3:

CALEX® Valve body

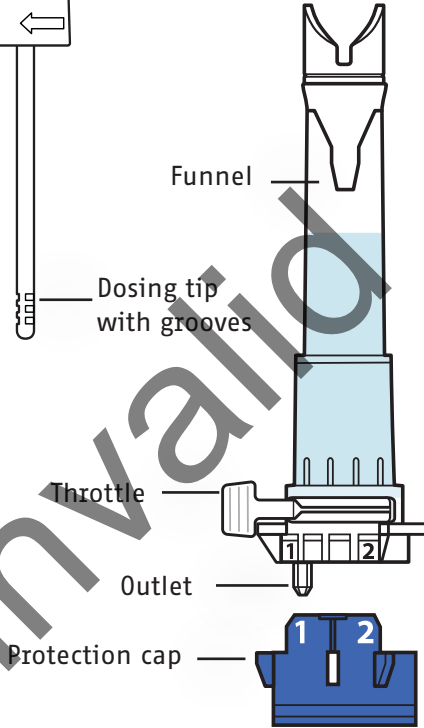

Figure 4: Test cassette

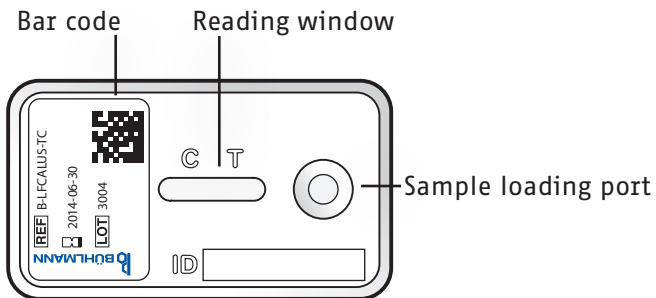
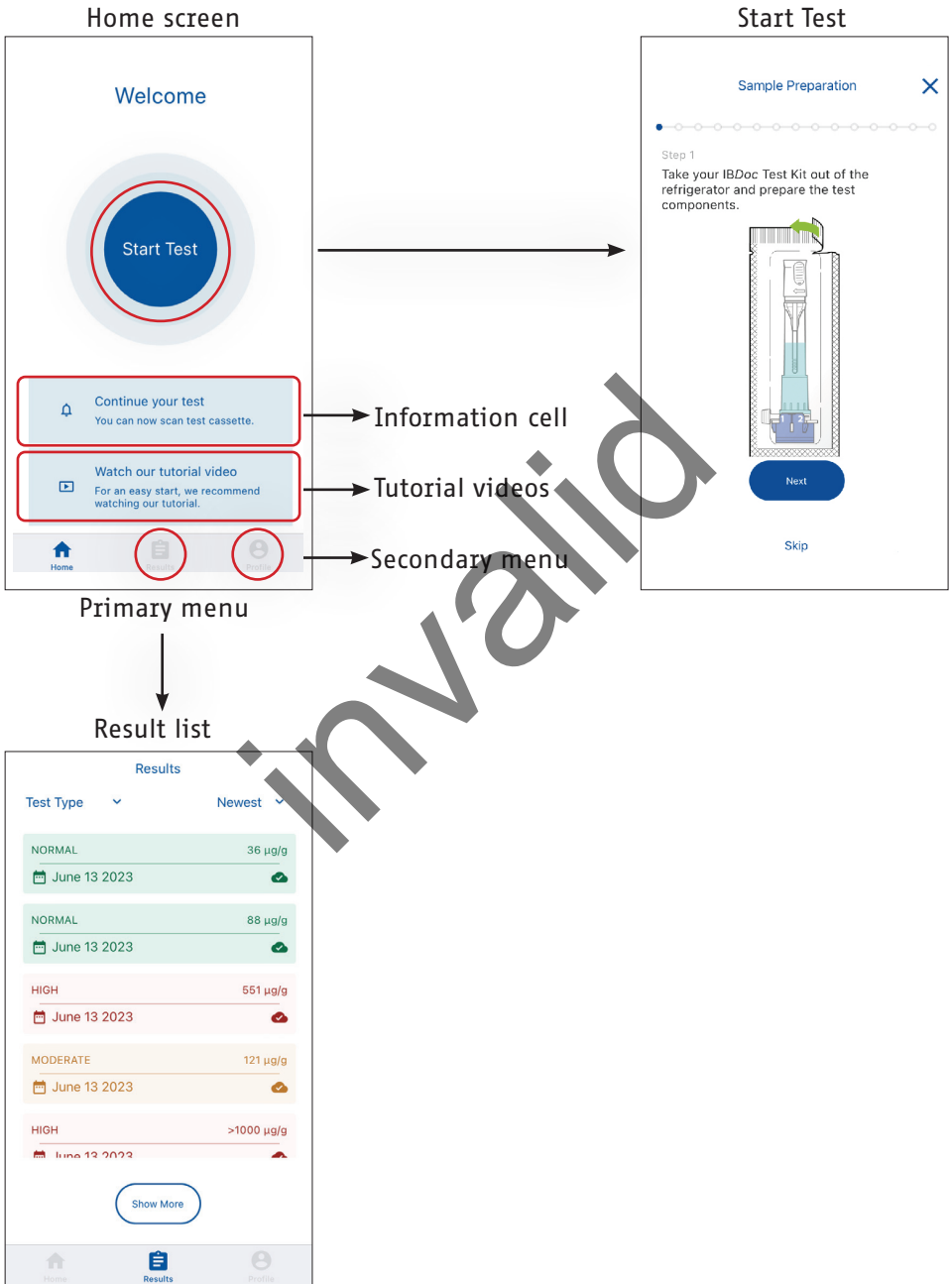

Figure 5: IBDoc® app navigation menu



# STEP 1: INSTALLATION OF THE APP AND LOGIN

1.1 Search for „IBDoc®“ on the Apple App store or Google Play store.

1.2 Download and install the IBDoc® app onto your smartphone (A).

**Note:** Please verify that you have an iOS or Android smartphone validated by BÜHLMANN. You can find a complete list of validated smartphones on [www.ibdoc.net](http://www.ibdoc.net). Login will be blocked on a smartphone that is not validated.

1.3 Make sure that you have a stable internet connection.

**Note:** Please be aware that you need an internet connection to log into IBDoc® app at first startup.

1.4 Tap on the IBDoc® icon and start the login process.

**Note:** At the first start up you will have to agree that the IBDoc® app is allowed to send you push notifications. A push notification will send you a reminder one day before the next test is due.

An onboarding screen explaining the IBDoc® system is shown at first start-up.

You will have to agree that the IBDoc® app is allowed to use the camera.

1.5 Enter your IBDoc® account email address (username) and password (B).

**Note:** If you forgot your password you can reset it by tapping on the „Forgot Password“ button (B). Once you entered your IBDoc® account email address (username), a link to reset your password will be sent to your email address.

1.6 Read and accept the End User Licence Agreement (EULA) and the Privacy Policy.

**Note:** Due to data protection and security reasons your session expires after 7 days and you will need to log in again.

A

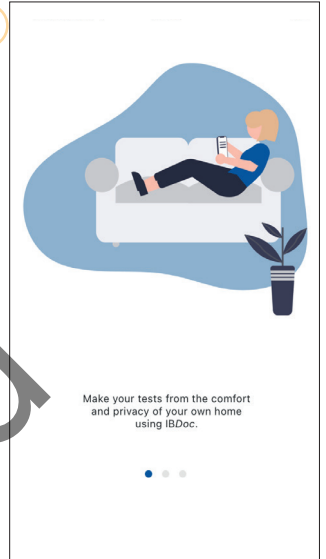

B

IBDoc®  
Login

Username  
abc@example.com

Password

Forgot Password?

Login

# STEP 2: PREPARATIONS FOR THE TEST PROCEDURE

- 2.1 After login you see the home screen (fig. 5, p. 7). To start your test, tap on the “Start Test” button (C).

**Note:** Two information cells are displayed on the Home Page (fig. 5, p. 7). The first one gives you information about your tests (date of the next test due, stage of the current test, etc). The second one will allow you to consult the tutorial video.

- 2.2 You can freely navigate between the tutorial screens and displayed text information (D). If you are an experienced user you may skip these instructions (by tapping the “skip” button) and start with the test procedure right away (see step 3).

- 2.3 Now you have completed the smartphone preparations. Put it aside but keep it in reach for later steps. Start with the test procedure (step 3).

Take the IBDoc® test set out of the fridge and keep the single components in a dry and shaded place until needed in the test procedure.

**Note:** Keep the test cassette in the pouch until you are ready to load the test cassette in step 5.

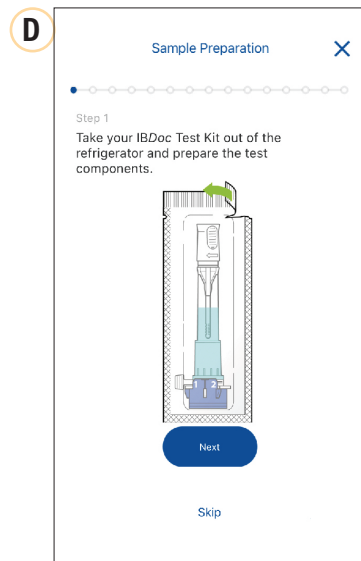
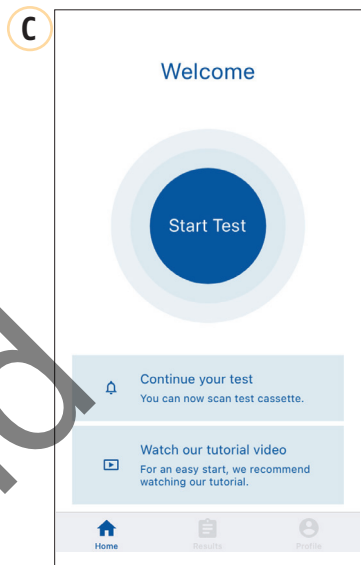

# STEP 3: STOOL COLLECTION

The subsequent steps 3 and 4 must be performed continuously without interruption

- 3.1 Please empty your bladder first if necessary, since urine can affect the test.
- 3.2 Unfold the stool collection paper by holding the open ends and gently pulling outwards (E).
- 3.3 Place the stool collection paper on top of the toilet seat near the back (F).

**Caution: The paper must not touch the toilet water.**

- 3.4 Make sure that the stool collection paper is correctly fixed on the toilet seat.
- 3.5 Make sure that your stool sample is caught on the collection paper (G).

**Note: In case your stool collection fails the first time, you have a second stool collection paper provided with the test kit.**

**If needed put your examination gloves on and proceed to step 4 of the test procedure.**

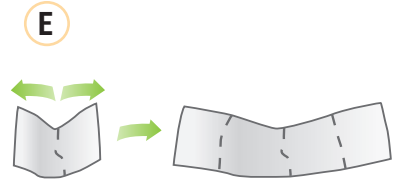

## STEP 4: STOOL EXTRACTION

- 4.1 Remove the CALEX® Valve from the packaging.
- 4.2 Hold the CALEX® Valve device with the white cap at the top and remove the white sampling pin by simultaneously turning clockwise and pulling it upwards (H).
- 4.3 Dip the dosing tip with the grooves into the stool, and twist before removing. Repeat the procedure at 3 to 5 different positions of the stool sample in order to fill the grooves of the dosing tip (fig. 2, p. 6) completely (I).

**Caution: Make sure that all grooves are completely filled with stool. It does not matter if the dosing tip of the sampling pin is fully covered with stool, since excess stool will be stripped off at the next step.**

- 4.4 Place the sampling pin back into the funnel of the CALEX® Valve body and push it into the final locking position. You feel and hear a “click” (J).

**Note: After the stool sample is collected, you can flush the remaining stool down the toilet together with the stool collection paper.**

- 4.5 Shake the CALEX® Valve vigorously for 10 seconds (K) and let it stand for 2 hours on the blue protection cap.

**Note: Since many stool samples require up to 2 hours to fully detach from the grooves you have to wait at least 2 hours before proceeding with the next step. Continue with the procedure at a convenient time point within the next 24 hours.**

**There is a 2 to 24 hours timer at this step in the app tutorial. If started, the timer will send you a notification when 2 hours are up or if 1 hour is left of the 24 hours.**

**Keep the CALEX® Valve device in a dry and shaded place during the waiting period.**

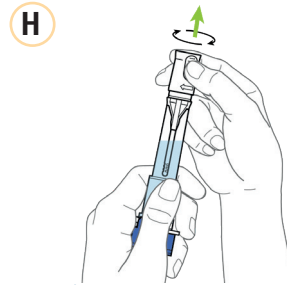

**Caution: Do not remove the blue protection cap!**

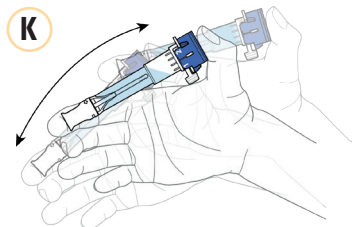
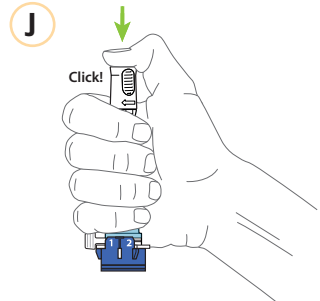
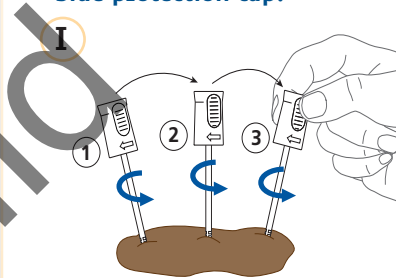

# STEP 5: LOADING THE TEST CASSETTE

The subsequent steps 5 to 7 must be performed continuously without interruption.

**Caution:** Make sure you have your smartphone ready and that you are logged into the IBDoc® app.

- 5.1 Unpack the test cassette.
- 5.2 Shake CALEX® Valve again vigorously for 10 seconds. Holding the CALEX® Valve upright, flick the bottom of the CALEX® Valve to remove any airbubbles trapped in the outlet (L).

**Caution:** To get accurate test results it is important that the grooves of the dosing tip are free before the next step. If there is any residual stool left in the dosing tip, repeat step 5.2 before continuing.

- 5.3 Remove the protection cap (M, 1) and place the outlet of the CALEX® Valve onto the circular sample loading port (fig. 4, p. 6) of the test cassette (M, 2). Turn the throttle (fig. 3, p. 6) from position 1 to position 2 counterclockwise (N) and make sure that the outlet remains in close contact with the sample loading port.

- 5.4 As the liquid is loaded (O, 1) a reddish color appears in the reading window. Allow the reddish color to reach the middle of the reading window of the test cassette (O, 2 arrow). This will take 20 to 30 seconds.

- 5.5 Start the timer in the IBDoc® app immediately (O, 3).

**Caution:** Open the throttle of the CALEX® Valve only once. The test is designed to work with the first drop released.

- 5.6 Remove the CALEX® Valve from the sample loading port of the test cassette and put the protection cap back on.

**Note:** The CALEX® Valve must be used only once.

- 5.7 Leave the test cassette for 12 minutes until the timer starts to “beep”. Then proceed immediately to step 6 of the test procedure.

**Note:** Make sure that your phone is not on mute, so you can hear the timer ring.

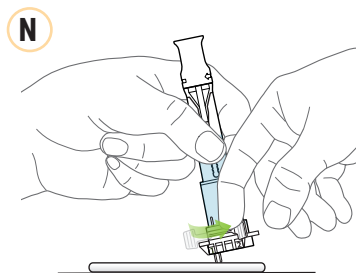
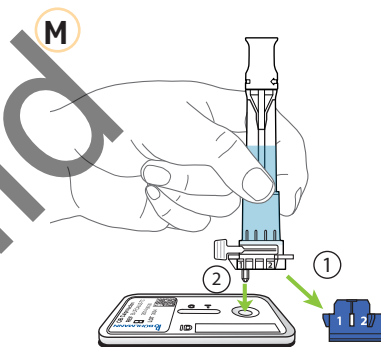
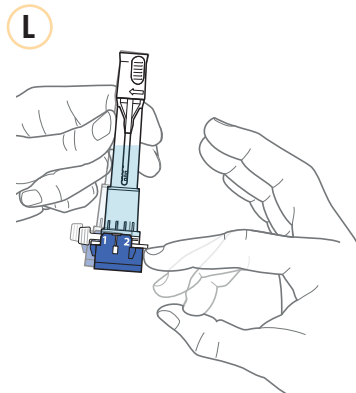

# STEP 6: READING THE TEST CASSETTE

**Note:** Make sure that the test cassette is positioned on a plain and uniform surface (P). Do not place test cassettes on furniture edges, patterned or dark backgrounds as this may interfere with the image capture by your smartphone.

- 6.1 Once the timer has run out, proceed immediately to take an image of the test cassette by pressing the „Scan“ button.

**Caution:** A time out message will appear 90 seconds after pressing the “Scan“ button. The camera view will close and the IBDoc® app will return to the start screen.

- 6.2 Align the frame in the camera view with the edges of the test cassette (R). Touch the screen to focus, if necessary.

**Note:** Hold your smartphone horizontally to the test cassette and not at an angle (Q).

Move smartphone slowly up and down to get the frame in proper alignment with the test cassette. If the smartphone is in the correct position, the frame will turn from red (R) to green (S). If the color does not change, touch the screen to refocus on the image. Once the position is indicated as correct (green), please hold your smartphone at the same position until the reading is complete. Please make sure that you scan the test cassette in under 1 minute.

- 6.3 Once the IBDoc® app has found 10 good images to analyse, five dots gradually appear and the screen displays „Analysing test“.

P

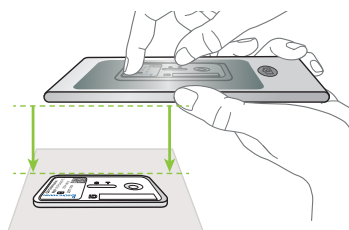

Q



R



S



# STEP 7: ADDING NOTES AND SAVING TEST RESULT

- 7.1 As soon as the test cassette has been read, the IBDoc® app takes you to the result view (T).

**Note:** If you do not have an internet connection while performing the test, the result may appear as „Pending“ in a blue box until an internet connection is established at the next login. Your test result is not lost in any case.

- 7.2 By tapping into the „Notes“ box you can leave a comment for yourself or for your healthcare professional.

**Note:** Only full stops and commas are allowed as punctuation marks.

- 7.3 Once you have typed your note, tap the „Submit“ button (T) to save the test result.

**Note:** Test results are sent automatically to the IBDoc® Portal and your HCP is notified via email. If the smartphone does not have an internet connection at the time the test cassette is measured, the test result is automatically sent the next time an internet connection is established.

You can review your test result history at any time by accessing the test result list or the mobile portal (fig. 5, p. 7).

- 7.4 After the test result is saved, dispose of the CALEX® Valve device and the test cassette (U).

- 7.5 You have reached the end of the test procedure. The IBDoc® app will return to the home screen.

**Caution:** Do not read the same test cassette again.

**Note:** Uploaded results will be displayed by a cloud symbol with a check mark. Results that are not yet uploaded to the IBDoc® Portal will be displayed with an arrow in the cloud symbol. You can perform a manual upload by manually pulling down the page to refresh the result list (fig. 5, p. 7).

T

Your Result

**NORMAL** <math>< 30 \mu\text{g/g}</math>  
Calprotectin  
Normal range: 30-100  $\mu\text{g/g}$

04 mai 2023  
15:21

Add your comment (optional)

Submit

After clicking submit, your test result and your comment will be automatically sent to your doctor.

U

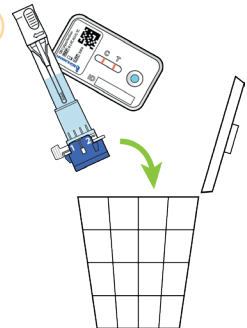

# QUALITY CONTROL FEATURES

Figure 6: Test results

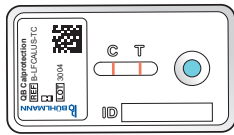

**VALID**

Control Line (C) and Test Line (T) are visible.

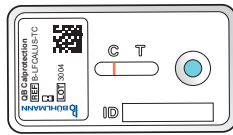

**VALID**

Control Line (C) is visible. The calprotectin concentration is below the detection limit and the Test Line (T) is not visible.

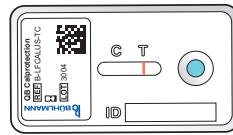

**INVALID**

Control Line (C) is not visible.

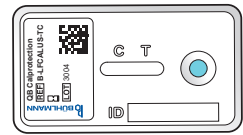

**INVALID**

Control Line (C) is not visible.

For a valid result, the Control Line (C) has to be visible. If the signal intensity of the Control Line (C) is below a threshold after 12 minutes of incubation time, the test result is also invalid and the test has to be repeated using another test cassette. The IBDoc® app determines the validity of the test cassette automatically.

## CRITICAL STEPS IN THE TEST PROCEDURE

To ensure optimal IBDoc® test performance always remember:

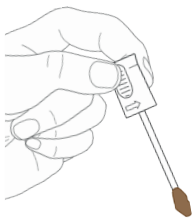

### Stool collection (step 4.3)

Make sure all the grooves of the sampling pin are completely filled with stool. Do not worry about excess stool. This will be removed by the CALEX® Valve.

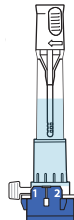

**Before you release the extract on the test cassette (step 5.3), allow the CALEX® Valve to stand for 2-24 hours at room temperature.**

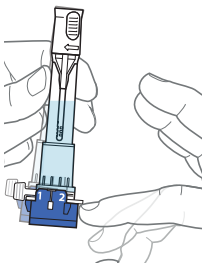

**Before you release the extract on the test cassette (step 5.3), flick the bottom of the CALEX® Valve to release any air bubbles trapped in the outlet.**

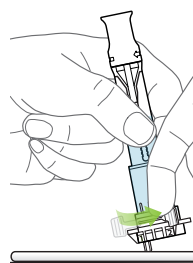

**During extract release onto the test cassette (step 5.4), keep the outlet of the CALEX® Valve in contact with the sample loading port until the reddish color reaches the middle of the test cassette.**

invalid

**THE NEXT SECTION OF THE INSTRUCTION FOR USE DESCRIBES THE RESULT INTERPRETATION AND PERFORMANCE EVALUATION OF THE IBDoc® AND IS IN PARTICULAR INTENDED FOR HEALTHCARE PRACTITIONERS.**



invalid

# LIMITATIONS AND CONTRAINDICATIONS

- Multiple fecal calprotectin measurements performed at up to 4 weeks intervals have been suggested to have best diagnostic accuracy in predicting clinical relapse in patients <sup>12, 13</sup>.
- It is advised that IBD patient monitoring with IBDoc<sup>®</sup> be established during disease remission. This will allow optimal determination of rising calprotectin levels that may indicate disease relapse.
- Fecal calprotectin levels determined by IBDoc<sup>®</sup> are intended as an aid to IBD monitoring and should be interpreted in combination with other clinical and laboratory findings.
- Fecal calprotectin results should be considered an adjunctive target for treatment <sup>11</sup>.
- IBDoc<sup>®</sup> testing should be performed by users ages 12 and above only.
- Fecal calprotectin levels in newborns and young children can be significantly increased <sup>14, 15</sup>.
- It is recommended that fecal calprotectin testing in patients below the age of 18 should be performed under parental supervision.
- In rare cases, when calprotectin levels are extremely high (above 4000 µg/g, ie. in acute UC), the test system may be prone to a high dose hook effect, that can result in values below the expected 850 µg/g upper limit (see performance). It is advised to give particular attention to IBDoc<sup>®</sup>-measured levels above 250 µg/g when accompanied by strong symptoms that could indicate acute inflammation. In this case retesting of a patient's stool sample by a laboratory in timely manner is recommended for confirmation.
- Patients that are on or have been on continuous NSAID medication (i.e., Aspirin<sup>®</sup>, Ibuprofen, Aleve<sup>®</sup>, Excedrin<sup>®</sup>) may have elevated fecal calprotectin values and specimens from these patients should not be tested or used as part of the diagnostic interpretation.
- Only validated smartphone models can be used with the IBDoc<sup>®</sup> (more information available on [www.ibdoc.net](http://www.ibdoc.net)).
- An additional control of the test strip image for any abnormalities is recommended when assessing IBDoc<sup>®</sup> test results. Please refer to fig. 6 p. 15.

# RESULT INTERPRETATION

The following *IBDoc*® result categories reflect condensed knowledge of published cut-offs and, specifically, clinical performance studies for BÜHLMANN fCAL tests (please refer to section: summary of clinical literature). Thresholds can be classified as a color code or as a value:

-  Normal: Fecal calprotectin levels below 100 µg/g can reliably indicate patients, with low risk of clinical relapse, in endoscopic remission. Invasive endoscopic procedures can be avoided in these patients<sup>1-11</sup>.
-  Moderate: Fecal calprotectin levels between 100-300 µg/g may indicate the necessity of tighter control in the following period to assess disease development tendencies. Particular attention should be paid to calprotectin values of 250 µg/g and above.
-  High: Fecal calprotectin levels above 300 µg/g should be repeated and, if raised levels are confirmed, prompt further investigative procedures<sup>1-11</sup>.

The above *IBDoc*® result categories are default settings and may be adjusted. It is advised that healthcare practitioners verify the default thresholds by determining the patient's baseline calprotectin level during disease remission.

A false negative result for a patient with endoscopic inflammation, that is a calprotectin result in a green category that should appear red, is highly unlikely. However it is important that the patient remains under the care of a healthcare practitioner and reports any clinical symptoms to prevent delay of appropriate clinical decisions and treatment, should a false negative result occur.

Studies have shown that high calprotectin levels, above 300 µg/g, will not always indicate development of a clinical relapse. High calprotectin levels should be treated as a red flag signal and repeated. Confirmation of raised levels should prompt further investigative procedures.

# SUMMARY OF CLINICAL LITERATURE

Correlation of calprotectin levels and the inflammatory state of patients' intestinal mucosa, according to endoscopic evaluations, were determined in three independent studies using BÜHLMANN fCAL tests.

	Study 1 (Spain) [Ref. 1]	Study 2 (Spain) [Ref. 2]	Study 3 (Australia, New Zealand) [Ref. 3]
<b>Patient number and demographics</b>	89 (CD <sup>1</sup> )  Ages 32-58 44% male	123 (UC <sup>2</sup> )  Ages: 18-85 66.4% male	99 (CD <sup>1</sup> after resection) Ages: 29-47 <sup>3</sup> 46.5% male
<b>Calprotectin level chosen as the decision point</b>	272 µg/g	280 µg/g	100 µg/g
<b>% of patients with values below the decision point in endoscopic remission<sup>4</sup></b>	98%	86%	91%
<b>% of patients with values above decision point with endoscopic relapse<sup>5</sup></b>	76%	80.3%	53%

Table 1: Correlation of calprotectin levels with IBD disease activity determined by endoscopic evaluations. Results for studies 1 and 2 were obtained with BÜHLMANN lateral flow assays (Quantum Blue® fCAL and Quantum Blue® fCAL high range). Results in study 3 were obtained with the BÜHLMANN fCAL® ELISA).

<sup>1</sup> CD = Crohn's disease patients,

<sup>2</sup> UC = Ulcerative Colitis patients,

<sup>3</sup> Interquartile range (IQR),

<sup>4</sup> Negative predictive values (true negative / (true negative + false negative)),

<sup>5</sup> Positive predictive values (true positive / (true positive + false positive)).

# SUMMARY OF CLINICAL LITERATURE

The diagnostic value of calprotectin in predicting clinical remission and relapse, according to patients symptoms, clinical activity indices, unplanned need for therapy escalation, hospitalization or emergency was determined in three studies using BÜHLMANN fCAL tests.

	Study 4 (UK) [Ref. 4]	Study 5 (Spain) [Ref. 5]	Study 6 (Spain) [Ref. 6]
<b>Number of patients in a study</b>	92 (CD <sup>1</sup> )  38 % male	30 (CD <sup>1</sup> ) adalimumab therapy  Ages: 24-64 43.3 % male	33 (CD <sup>1</sup> ) 20 (UC <sup>2</sup> ) infliximab therapy  Ages: 18-68 47.2 % male
<b>Follow-up time after calprotectin measurement</b>	12 months	4 months	12 months
<b>Calprotectin level chosen as decision point</b>	240 µg/g	204 µg/g	160 µg/g
<b>% of patients with values below decision point in clinical remission<sup>3</sup></b>	96.8 %	100 %	96.1 %
<b>% of patients with values above decision point in clinical relapse<sup>4</sup></b>	27.6 %	75 %	68.7 %

Table 2: Results for study 4 were obtained with the BÜHLMANN fCAL® ELISA. Results for studies 5 & 6 were obtained with BÜHLMANN lateral flow assays (Quantum Blue® fCAL and Quantum Blue® fCAL high range).

<sup>1</sup> CD = Crohn's disease patients

<sup>2</sup> UC = Ulcerative Colitis patients

<sup>3</sup> Negative predictive values (true negative / (true negative + false negative))

<sup>4</sup> Positive predictive values (true positive / (true positive + false positive)).

## USER PERFORMANCE EVALUATION

Seventy five (75) patients diagnosed with Ulcerative Colitis or Crohn's disease, according to classical criteria (64.2% female, ages 18-69) were enrolled at three study sites and provided a single stool specimen. IBDoc® test results were generated by the patients with their own smartphones as well as by healthcare providers using the Samsung Galaxy® S4 and iPhone® 6 smartphone models, running the Android and iOS version of the IBDoc® app software, respectively. IBDoc® results were compared to reference calprotectin values from the same sample. To establish reference values multiple measurements of three independent CALEX® Cap stool extractions were performed with the BÜHLMANN fCAL® ELISA in a laboratory.

None of the 75 patients obtained a false-positive result (red → green) or false-negative (green → red) result (see table 3). The total within-result category agreement achieved by the patients was 81 % in comparison to a total agreement of 91 % obtained by HCPs. (To optimize test performance, please refer to the critical steps in the test procedure section).

		Normal <100	Moderate 100-300	High >300	Total
IBDoc® Patient	Normal <100	24	2	0	26
	Moderate 100-300	3	7	7	17
	High >300	0	2	30	32
	Total	27	11	37	75
FC references values					

Table 3: Agreement of results obtained by patients using IBDoc® with laboratory reference measurements (BÜHLMANN fCAL® ELISA) from the same stool sample.

# PERFORMANCE CHARACTERISTICS

## METHOD COMPARISON

Forty (40) leftover clinical specimens with calprotectin levels in the range of 46-708 µg/g were measured with IBDoc® according to the instruction for use, using three different test cassette lots. The test cassettes were analyzed with Samsung Galaxy® S4 and iPhone® 6 smartphone models running the Android and iOS versions of the IBDoc® app software, respectively. The obtained results were compared to reference calprotectin values determined as a mean of multiple BÜHLMANN fCAL® ELISA measurements of three CALEX® Cap extracts, prepared from each stool specimen. Method comparison was performed using Passing-Bablok regression analysis. Bias at clinical decision points determined for each test cassette lot and smartphone model are described in table 4. Examples of Passing-Bablok regression analysis for test cassette lot 1918 are depicted in figure 7.

Smartphone	Samsung Galaxy® S4 (Android)			iPhone® 6 (iOS)		
Test cassette lot	1918	1919	4325	1918	1919	4325
Bias at 100 µg/g	-14.0%	8.6%	-1.4%	-2.3%	20.9%	9.6%
Bias at 300 µg/g	-6.7%	8.7%	-7.2%	-1.0%	13.3%	3.9%

Table 4: Bias of IBDoc® measurements at clinical decision points when compared to reference calprotectin values obtained with the BÜHLMANN fCAL® ELISA test. IBDoc® measurements were performed with three test cassette lots: 1918, 1919, 4325 and two smartphone models.

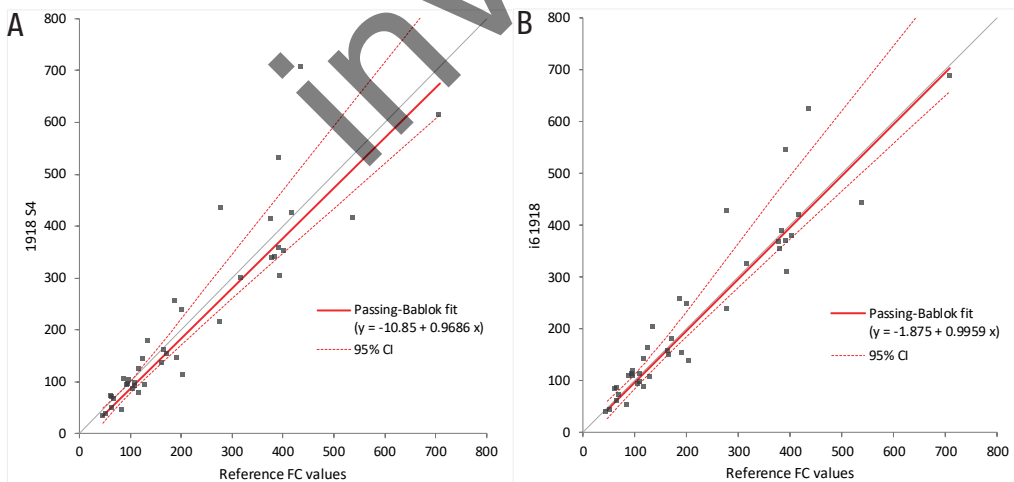

Figure 7: Passing-Bablok regression analysis of IBDoc® results obtained with test cassette lot 1918 and Samsung Galaxy® S4 (A) and iPhone® 6 (B) smartphones compared to reference calprotectin values.

## READER COMPARISON

All IBDoc® test cassettes obtained in the method comparison study were additionally analyzed with the Quantum Blue® Reader – a dedicated instrument for BÜHLMANN lateral flow assay analysis. The comparison between smartphone readings and Quantum Blue® Reader results are summarized in table 5 and figure 8.

Smartphone	Samsung Galaxy® S4 (Android)	iPhone® 6 (iOS)
Test cassette lot	1918, 1919, 4325	1918, 1919, 4325
Bias at 100 µg/g	-7.6 %	5.4 %
Bias at 300 µg/g	-4.4 %	6.5 %

Table 5: Bias of IBDoc® app measurements performed with Samsung Galaxy® S4 and iPhone® 6 smartphones at clinical decision points when compared to Quantum Blue® dedicated reader measurements.

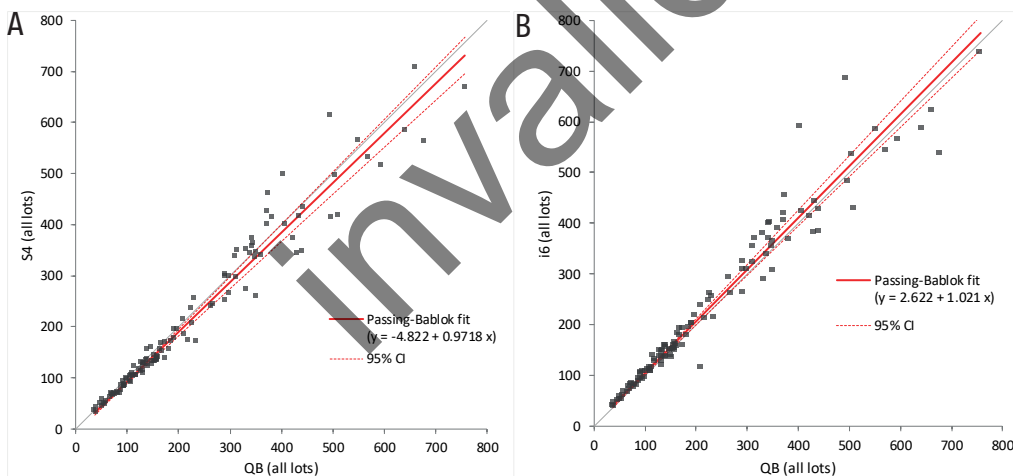

Figure 8: Passing-Bablok regression analysis of Samsung Galaxy® S4 (A) and iPhone® 6 (B) smartphone readings compared to results obtained with the Quantum Blue® Reader.

# PERFORMANCE CHARACTERISTICS

## RECOVERY

Six stool specimen extracts were spiked with 150 µg/g calprotectin in calibrator material of human serum origin. The „baseline“ extract was spiked with the corresponding amount of extraction buffer. „Baseline“ and „spiked“ samples were measured in eight replicates with the IBDoc® assay. One test cassette lot was used. The results were analyzed using Samsung Galaxy® S4 and iPhone® 6 smartphones, running the Android and iOS versions of the IBDoc® app, respectively. The results are summarized in table 6.

Samsung Galaxy® S4	Sample	# 1	# 2	# 3	# 4	# 5	# 6
	Baseline [µg/g]	65.1	87.6	110.5	196.4	186.0	282.4
	Spike value [µg/g]	150.0	150.0	150.0	150.0	150.0	150.0
	Expected (baseline+spike) [µg/g]	215.1	237.6	260.5	346.4	336.0	432.4
	Observed [µg/g]	208.1	226.3	280.0	354.1	349.0	450.5
	% Recovery (observed/expected)	96.7	95.2	107.5	102.2	103.9	104.2
iPhone® 6	Sample	# 1	# 2	# 3	# 4	# 5	# 6
	Baseline [µg/g]	73.8	109.4	132.9	230.5	216.3	319.6
	Spike value [µg/g]	150.0	150.0	150.0	150.0	150.0	150.0
	Expected (baseline+spike) [µg/g]	223.8	259.4	282.9	380.5	366.3	469.6
	Observed [µg/g]	246.3	264.4	324.8	385.9	399.0	478.6
	% Recovery (observed/expected)	110.1	101.9	114.8	101.4	108.9	101.9

Table 6: IBDoc® recovery results obtained with one test cassette lot, analyzed with Samsung Galaxy® S4 and iPhone® 6 smartphones.

# PERFORMANCE CHARACTERISTICS

## PRECISION

**Repeatability: 12.9–23.3 % CV**

**Within-laboratory precision: 16.7–28.3 % CV**

**Intermediate precision 1 (3 laboratory locations): 16.4–22.5 % CV**

**Intermediate precision 2 (3 test cassette lots): 13.1–22.5 % CV**

The precision study was designed according to the CLSI guideline EP05-A2. Precision was determined with four stool sample extracts with calprotectin values covering the assay measuring range. Two of the samples were chosen to correspond to the 100 µg/g and 300 µg/g clinical decision points.

Within-laboratory precision was determined by performing duplicate measurements in two runs, one in the morning, one in the afternoon, over a period of 10 days. To determine intermediate precision, in a first study, three different operators, at three different laboratory locations with different lighting conditions, performed duplicate measurements in a morning and an afternoon run over a period of 5 days. In a second study, intermediate precision was determined using three different IBDoc® test cassette lots. Duplicate measurements were performed over a period of 5 days.

All IBDoc® results obtained in the precision study were analyzed using two different smartphone models: The Samsung Galaxy® S4 and iPhone® 6 and running the Android and iOS versions of the IBDoc® app, respectively. Three different iPhone® 6 devices were used for the intermediate precision study at 3 laboratory locations.

The final values are presented as coefficients of variation (table 7, 8).

Sample	Mean FC conc. [µg/g]	Repeatability [% CV]	Within-lab precision [% CV]	Mean FC conc. [µg/g]	Intermediate precision 1 [% CV]	Mean FC conc. [µg/g]	Intermediate precision 2 [% CV]
1	51.3	19.0	28.4	45.7	19.3	44.7	20.1
2	111.6	17.0	19.6	112.6	16.1	100.6	17.5
3	292.9	12.9	17.1	296.1	15.4	281.6	19.0
4	574.7	13.9	17.2	580.1	16.4	640.8	13.1

Table 7: Precision data of IBDoc® results analyzed with Samsung Galaxy® S4 running the Android version of the IBDoc® app.

Sample	Mean FC conc. [µg/g]	Repeatability [% CV]	Within-lab precision [% CV]	Mean FC conc. [µg/g]	Intermediate precision 1 [% CV]	Mean FC conc. [µg/g]	Intermediate precision 2 [% CV]
1	52.0	14.0	20.1	49.6	17.7	50.9	22.5
2	125.7	17.2	24.3	126.1	22.5	114.2	17.1
3	300.2	16.2	16.7	298.2	17.3	292.4	13.9
4	570.6	23.3	23.3	562.6	21.5	662.1	17.2

Table 8: Precision data of IBDoc® results analyzed with iPhone® 6 running the iOS version of the IBDoc® app.

## LIMIT OF BLANK AND LIMIT OF DETECTION

**Limit of Blank (LoB)** - highest measurement result, that is likely to be observed with a 95 % probability for a blank sample. The LoB was established according to the CLSI guideline EP17-A. Extraction buffer was used as a blank sample, as stool specimens negative for calprotectin do not occur naturally. The negative samples were measured on 60 IBDoc® test cassettes. The study was repeated with a second test cassette lot.

**Limit of Detection (LoD)** - the lowest concentration of calprotectin that can be detected in over 95 % of the samples. The LoD was established according to the CLSI guideline EP17-A. Two different stool specimens were used to generate a total of six samples by dilution in extraction buffer to achieve the range of 1 LoB-4 LoB. Each sample was measured in ten replicates (60 IBDoc® test cassettes in total). The study was repeated with a second test cassette lot.

All IBDoc® results obtained in the sensitivity study were analyzed using two different smartphone models: The Samsung Galaxy® S4 and iPhone® 6, running the Android and iOS versions of the the IBDoc® app, respectively. The results of LoB and LoD studies for IBDoc® are summarized in table 9.

Smartphone	Lot	Limit of Blank (LoB)	Limit of Detection (LoD)
Android OS	1	8.9 µg/g	13.9 µg/g
Android OS	2	15.0 µg/g	22.8 µg/g
iOS	1	<b>15.9 µg/g</b>	<b>29.1 µg/g</b>
iOS	2	9.9 µg/g	19.7 µg/g

Table 9: Limit of Blank and Limit of Detection values obtained with two different smartphone models and two test cassette lots.

## LIMIT OF QUANTITATION

**Lower LoQ <30 µg/g (28.2 µg/g)**

**Upper LoQ >1000 µg/g (1001.7 µg/g)**

**Lower Limit of Quantitation (Lower LoQ)** - the lowest concentration of calprotectin that can be detected with a total error (combined error of imprecision and bias) of <30%. Four low level stool extracts with calprotectin concentrations ranging from 19.1 to 37.3 µg/g were measured in ten replicates to produce 40 values.

**Upper Limit of Quantitation (Upper LoQ)** - the highest concentration of calprotectin that can be detected with a total error (combined error of imprecision and bias) of <30%. Four high level stool extracts with calprotectin concentrations ranging from 628 to 1001.7 µg/g were measured in ten replicates to produce 40 values.

The study was performed with two different test cassette lots. For bias estimation, reference calprotectin values of extracted stool samples were determined with the BÜHLMANN fCAL® ELISA. Calculation of the LoQ was performed using to the RMS model described in CLSI guideline EP17-A2. Lateral flow assay results were analyzed with the Quantum Blue® Reader, instead of the IBDoc® app software, as both reader systems show high agreement (please refer to section reader comparison). The results of LoQ studies for test cassette lot M0527 are summarized in tables 10 and 11.

Reference value [µg/g]	Observed value [µg/g]	Bias (reference - observed value) [µg/g]	Precision [% CV]	Relative total error [%]
37.3	29.2	-8.1	17.5	25.7
<b>28.2</b>	<b>21.3</b>	<b>-6.9</b>	<b>16.7</b>	<b>27.8</b>
23.6	17.6	-6.0	25.6	31.9
19.1	13.6	-5.5	20.6	32.2

Table 10: Bias, precision and relative total error results obtained for low level samples around 30 µg/g with lot M0527. The lower LoQ is indicated in bold.

Reference value [µg/g]	Observed value [µg/g]	Bias (reference - observed value) [µg/g]	Precision [% CV]	Relative total error [%]
<b>1001.7</b>	<b>752.6</b>	<b>-249.1</b>	<b>18.4</b>	<b>28.4</b>
746.0	706.9	-39.1	16.2	16.2
678.6	704.2	25.6	14.0	15.1
628.0	668.4	40.4	21.3	23.5

Table 11: Bias, precision and relative total error results obtained for high level samples with lot M0527. The upper LoQ is indicated in bold.

## LINEARITY

### Linear range: 30 - 850 µg/g

The linear range was determined according to CLSI guideline EP06-A. Two extracted stool samples with low and high calprotectin concentrations were blended to obtain a total of 14 concentration levels covering and exceeding the expected measuring range of the test. The blends were assayed in ten replicates on two test cassette lots. Mean calprotectin concentration values obtained for each blend were plotted against their theoretical concentration. Linear as well as non-linear polynomial, fitting was applied. An example of linearity analysis for test cassette lot M0527 is depicted in figure 9. Where the non-linear fits were determined to be significant, the linear range was defined as the interval of calprotectin concentration in which deviation from the linear fit did not exceed 20% relative concentration or 20 µg/g.

Lateral flow assay results were analyzed with the Quantum Blue® Reader, instead of the the IBDoc® app software, as both reader systems show high agreement (please refer to section reader comparison).

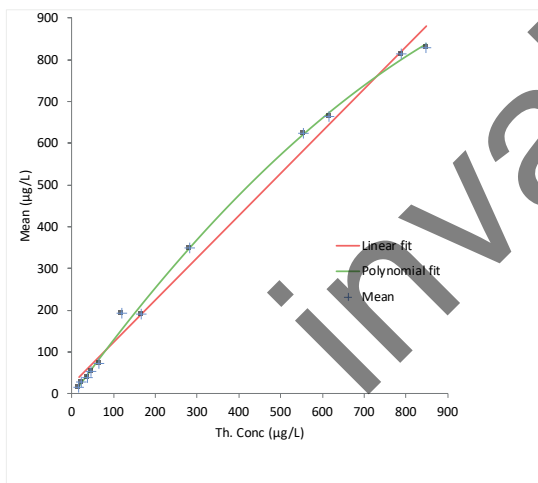

Figure 9: linear and polynomial fitting of data obtained with blends of a low and high calprotectin extract, covering the measuring range of the test, using test cassette lot M0527.

## HIGH DOSE HOOK EFFECT

No high dose hook effect was observed for calprotectin concentrations up to 1500 µg/g. Decrease in mean signal below the 850 µg/g upper linear range limit was estimated for calprotectin concentrations above 4000 µg/g. No value below the highest clinical decision point of 300 µg/g was observed for any of the single replicate results for all high samples tested. In total, seven to eight extracted stool samples with calprotectin concentrations ranging from 1361 µg/g to 13817 µg/g were measured in five replicates on three different test cassette lots.

## INTERFERING SUBSTANCES

All BÜHLMANN fCAL lateral flow assays use the same extraction buffer, lateral flow technology and antibodies. Interference studies were performed with the BÜHLMANN Quantum Blue® fCAL and fCAL high range assays in accordance with CLSI guideline EP7-A2. Interference of pharmaceuticals, food supplements, hemoglobin and enteropathic microorganisms was investigated by “paired-difference testing” in stool extracts with calprotectin target values of 50 µg/g and 250 µg/g calprotectin. Duplicate measurements of control and spiked extracts were performed. No interference has been shown with substances listed in table 12 and 13 for BÜHLMANN calprotectin lateral flow assays.

Drug trade name	Spiked concentration (mg/mL)
Ferro-Gradumed	0.04 mg/mL
Prednison	0.13 mg/mL
Imurek	0.07 mg/mL
Pentasa	2.00 mg/mL
Lansoprazol	0.07 mg/mL
Asacol	0.50 mg/mL
Vancomycin	0.80 mg/mL
Sulfametoazol	0.64 mg/mL
Trimethoprim	0.13 mg/mL
Ciprofloxacin	0.08 mg/mL
Food supplement	Spiked concentration (mg/mL)
Vitamin E	0.12 mg/mL
Multiple Vitamin	0.43 mg/mL
Hemoglobin	Spiked concentration (mg/mL)
Human hemoglobin	0.5 mg/mL

Table 12: Substances and their levels that were tested and show no interference with BÜHLMANN calprotectin lateral flow assays.









Microorganism	OD of culture
<i>Escherichia coli</i>	0.87
<i>Salmonella enterica subsp. enterica</i>	1.81
<i>Klebsiella pneumoniae subsp. pneumonia</i>	1.33
<i>Citrobacter freundii</i>	0.64
<i>Shigella flexneri</i>	0.23
<i>Yersinia enterocolitica subsp. enterocolitica</i>	0.91

Table 13: Microorganisms that were tested and show no interference in BÜHLMANN calprotectin lateral flow assays.

1. Lobatón T, López-García A, Rodríguez-Moranta F, et al. A new rapid test for fecal calprotectin predicts endoscopic remission and postoperative recurrence in Crohn's disease. *J Crohns Colitis*. 2013, 7(12):e641-51.
2. Lobatón Ortega T, Rodríguez-Moranta F, Lopez A, et al. A new rapid quantitative test for fecal calprotectin predicts endoscopic activity in ulcerative colitis. *Inflamm Bowel Dis*. 2013, 19(5):1034-42.
3. Wright EK, Kamm MA, De Cruz P, et al., Measurement of fecal calprotectin improves monitoring and detection of recurrence of Crohn's disease after surgery. *Gastroenterology*. 2015, 148(5):938-947.
4. Naismith GD, Smith LA, Barry SJ et al. A prospective evaluation of the predictive value of faecal calprotectin in quiescent Crohn's disease. *J Crohns Colitis*. 2014, 8(9):1022-9.
5. Ferreiro-Iglesias R, Barreiro-de Acosta M, Lorenzo-Gonzalez A et al. Usefulness of a rapid faecal calprotectin test to predict relapse in Crohn's disease patients on maintenance treatment with adalimumab. *Scand J Gastroenterol*. 2015, 23:1-6.
6. Ferreiro-Iglesias R1, Barreiro-de Acosta M, Otero Santiago M, Lorenzo Gonzalez A, Alonso de la Peña C, Benitez Estevez AJ, Dominguez-Muñoz JE. Fecal calprotectin as Predictor of Relapse in Patients With Inflammatory Bowel Disease Under Maintenance Influximab Therapy. *J Clin Gastroenterol*. 2015, 50(2):147-51.
7. Guardiola J., Lobatón T, Rodríguez-Alonso L, et al. Fecal Level of calprotectin Identifies Histologic Inflammation in Patients with Ulcerative Colitis In Clinical And Endoscopic Remission. *Clinical Gastroenterology and Hepatology* 2014, 12(11):1865-70.
8. Lason A, Öhman L, Stotzer PO et al. Pharmacological intervention based on fecal calprotectin levels in patients with ulcerative colitis at high risk of a relapse: A prospective, randomized, controlled study. *United European Gastroenterol J*. 2015 ;3(1):72-9.
9. Lin JF, Chen JM, Zuo JH et al. Meta-analysis: fecal calprotectin for assessment of inflammatory bowel disease activity. *Inflamm Bowel Dis*. 2014 Aug;20(8):1407-15.
10. Bressler B, Panaccione R, Fedorak RN, et al. Clinicians' guide to the use of fecal calprotectin to identify and monitor disease activity in inflammatory bowel disease. *Can J Gastroenterol Hepatol*. 2015, 29(7):369-72.
11. Peyrin-BI, Sandborn W, Sands BE et al. Selecting Therapeutic Targets in Inflammatory Bowel Disease (STRIDE): Determining Therapeutic Goals for Treat-to-Target. *Am J Gastroenterol*. 2015, 110:1324-38
12. Molander P, Färkkiläb M, Ristimäki A, et al. Does Fecal calprotectin Predict Short-Term Relapse After Stopping Tnfalpha-Blocking Agents In Inflammatory Bowel Disease Patients In Deep Remission? *Journal of Crohn's and Colitis*, 2015, 33-40.
13. De Vos M, Dewit O, D'Haens G et al. Consecutive fecal calprotectin measurements to predict relapse in patients with ulcerative colitis receiving infliximab maintenance therapy. *Inflamm Bowel Dis*. 2013, 9:2111-2117.
14. Fagerberg UL, Löf L, Myrdal U et al. Colorectal inflammation is well predicted by fecal calprotectin in children with gastrointestinal symptoms. *J Pediatr Gastroenterol Nutr*. 2005, 40(4):450-5.
15. Kapel N, Campeotto F, Kalach N et al. Faecal calprotectin in term and preterm neonates. *J Pediatr Gastroenterol Nutr*. 2010 51(5):542-7.

# INCIDENT REPORTING IN EU MEMBER STATES

If any serious incident in relation to this device has occurred, please report without delay to the manufacturer and competent authority of your Member State.

Symbol	Explanation
	Use by
	Consult Instruction for Use
	Temperature limitation
	Batch code
	Order Code
	Manufacturer
	Number of Tests
	Do not re-use
	Translation

CALEX® and IBDoc® are registered trademarks of BÜHLMANN in many countries.

Parts of the kit are patent protected by EP2617362(B1); EP2833795(B1); EP2947459(B1); US9752967(B2); US10620216(B2); AU2013210989(B2); AU2016203121(C1); AU2015261919(B2); BR112014017755-4; CA2861386(C); CA2997598(C); JP6043365(B2); JP6307132(B2); JP6467436(B2); KR10-1716740(B1); KR10-1875862(B1); ZL 201380009198.3



BÜHLMANN Laboratories AG  
Baselstrasse 55  
4124 Schönenbuch  
Switzerland

Phone +41 61 487 12 12  
Fax orders +41 61 487 12 99  
info@buhlmannlabs.ch  
www.buhlmannlabs.ch